

問題 不足している線を補い、三面図を完成させましょう。

①

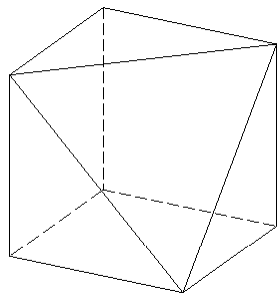

立体図

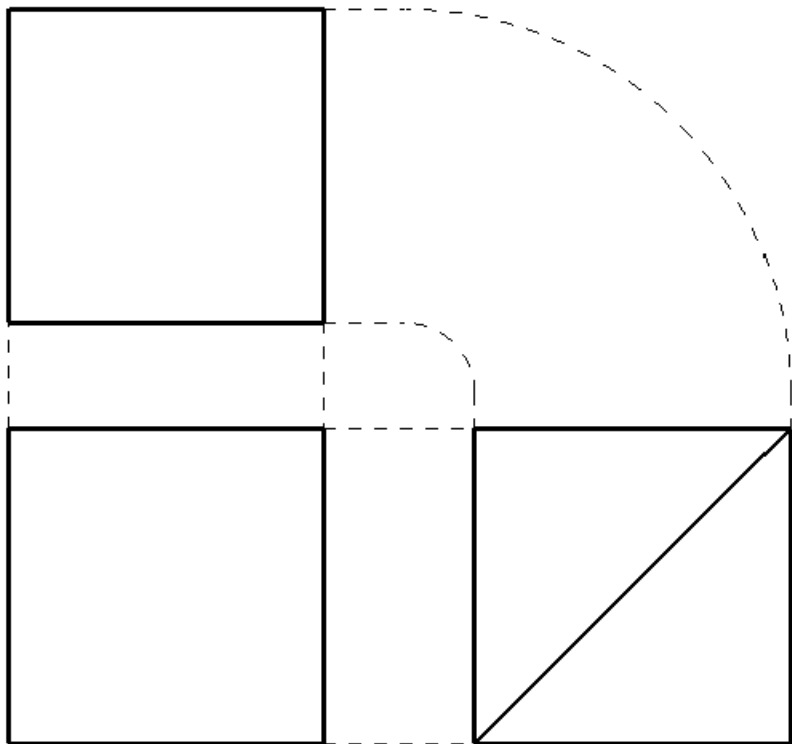

②

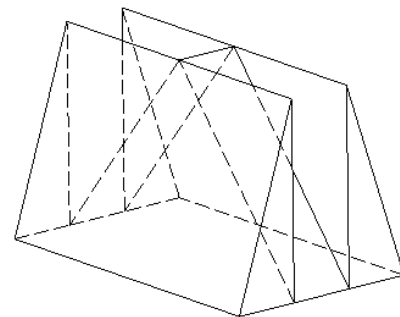

立体図

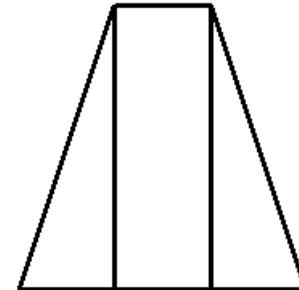
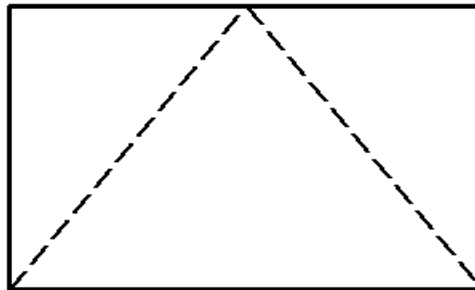
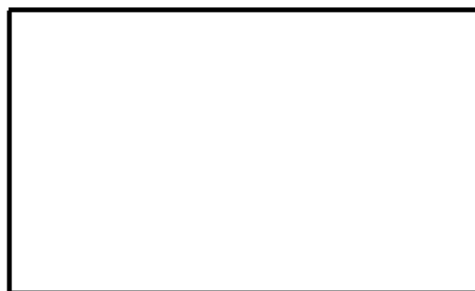

問題 三面図を立体図にしましょう。

③

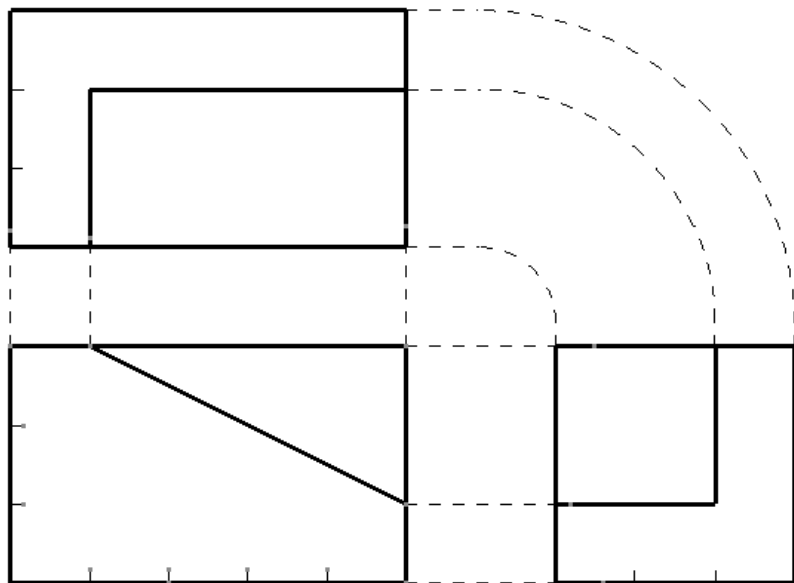
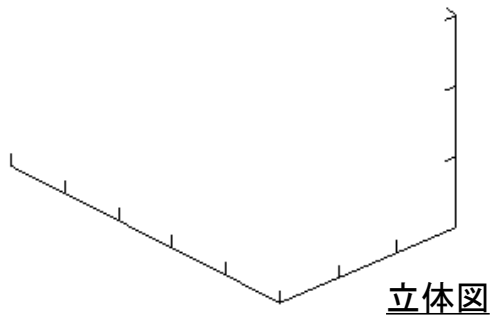

④

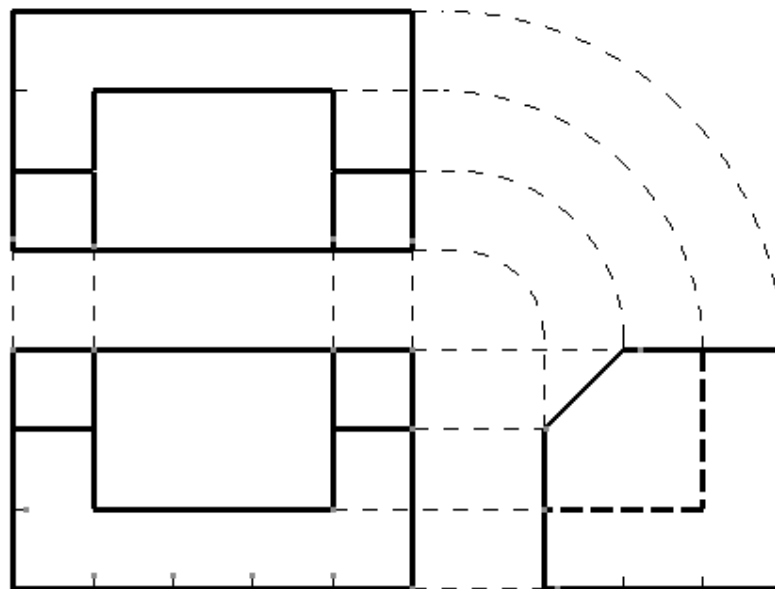
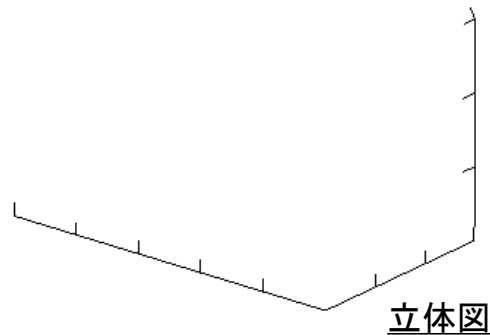

問題 不足している線を補い、三面図を完成させましょう。

⑤

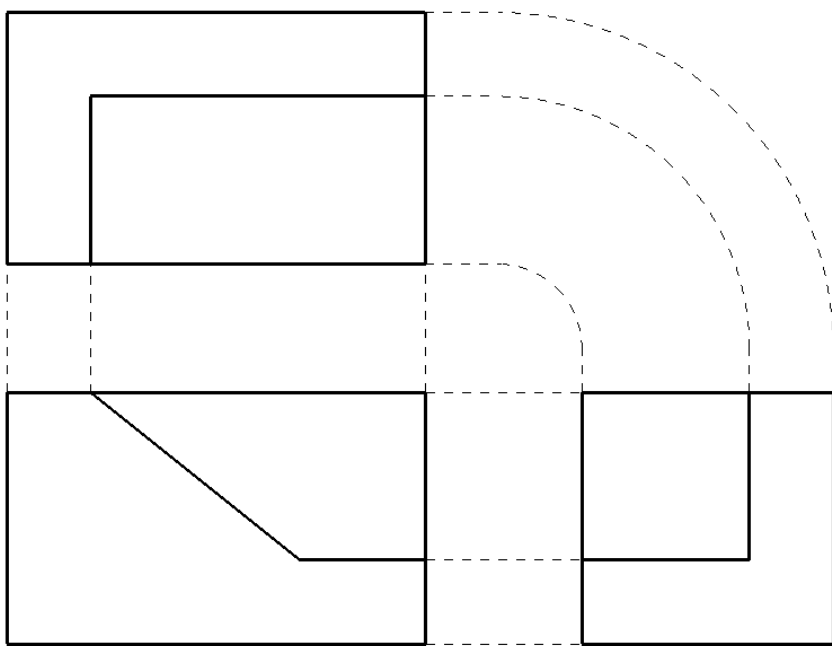

⑥

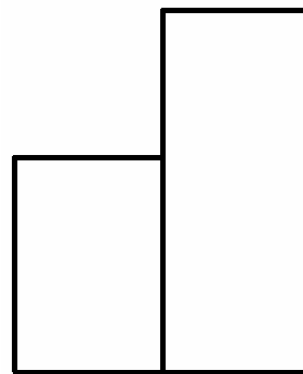
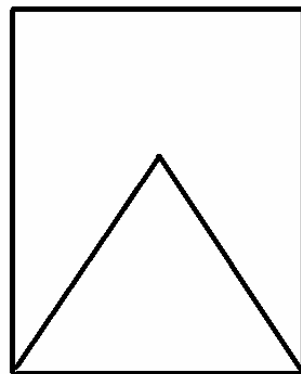
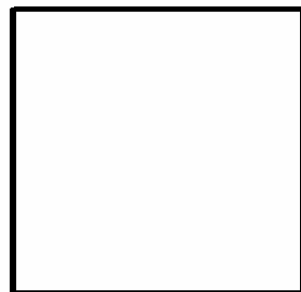

問題 欠けた図を描いて、三面図を完成させましょう。

⑦

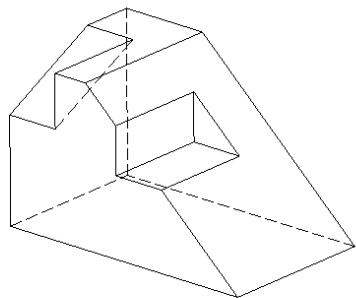

立体図

┌

└

└

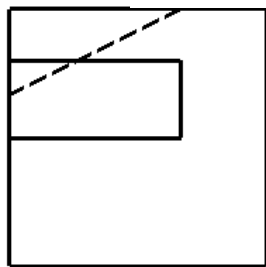
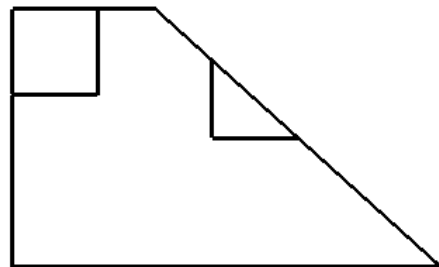

⑧

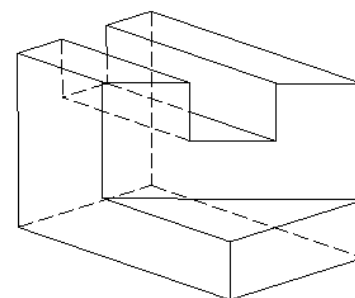

立体図

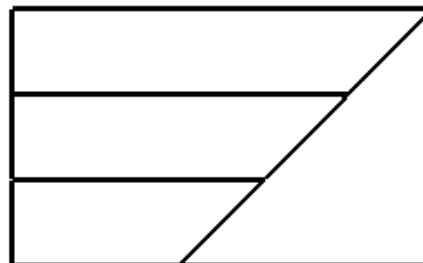

└

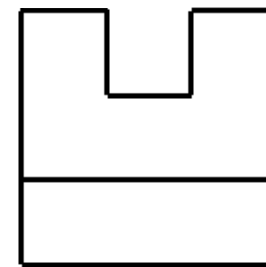

問題 欠けた図を描いて、三面図を完成させましょう。

⑨

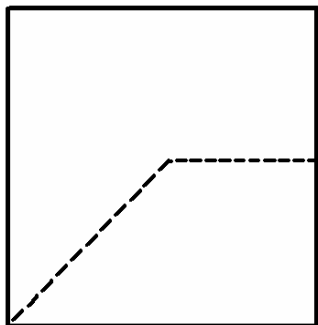
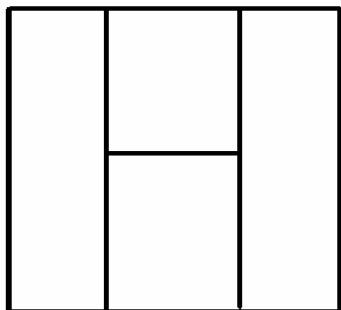

⑩

